

Module 1

Power Semiconductor Devices

Lesson 2

Constructional Features, Operating Principle, Characteristics and Specification of Power Semiconductor Diode

Instructional Objective

On Completion the student will be able to

1. Draw the spatial distribution of charge density, electric field and electric potential in a step junction **p-n** diode.
2. Calculate the voltage drop across a forward biased diode for a given forward current and vice-verse.
3. Identify the constructional features that distinguish a power diode from a signal level diode.
4. Differentiate between different reverse voltage ratings found in a Power Diode specification sheet.
5. Identify the difference between the forward characteristic of a power diode and a signal level diode and explain it.
6. Evaluate the forward current specifications of a diode for a given application.
7. Draw the “Turn On” and “Turn Off” characteristics of a power diode.
8. Define “Forward recovery voltage”, “Reverse recovery current” “Reverse Recovery charge” as applicable to a power diode.

Power Semiconductor Diodes

2.1 Introduction

Power semiconductor diode is the “power level” counter part of the “low power signal diodes” with which most of us have some degree of familiarity. These power devices, however, are required to carry up to several KA of current under forward bias condition and block up to several KV under reverse biased condition. These extreme requirements call for important structural changes in a power diode which significantly affect their operating characteristics. These structural modifications are generic in the sense that the same basic modifications are applied to all other low power semiconductor devices (all of which have one or more p-n junctions) to scale up their power capabilities. It is, therefore, important to understand the nature and implication of these modifications in relation to the simplest of the power devices, i.e., a power semiconductor diode.

2.2 Review of Basic p-n Diode Characteristics

A **p-n** junction diode is formed by placing **p** and **n** type semiconductor materials in intimate contact on an atomic scale. This may be achieved by diffusing acceptor impurities in to an **n** type silicon crystal or by the opposite sequence.

In an open circuit **p-n** junction diode, majority carriers from either side will diffuse across the junction to the opposite side where they are in minority. These diffusing carriers will leave behind a region of ionized atoms at the immediate vicinity of the metallurgical junction. This region of immobile ionized atoms is called the space charge region. This process continues till the resultant electric field (created by the space charge density) and the potential barrier at the junction builds up to sufficient level to prevent any further migration of carriers. At this point the **p-n** junction is said to be in thermal equilibrium condition. Variation of the space charge density, the electric field and the potential along the device is shown in Fig 2.1 (a).

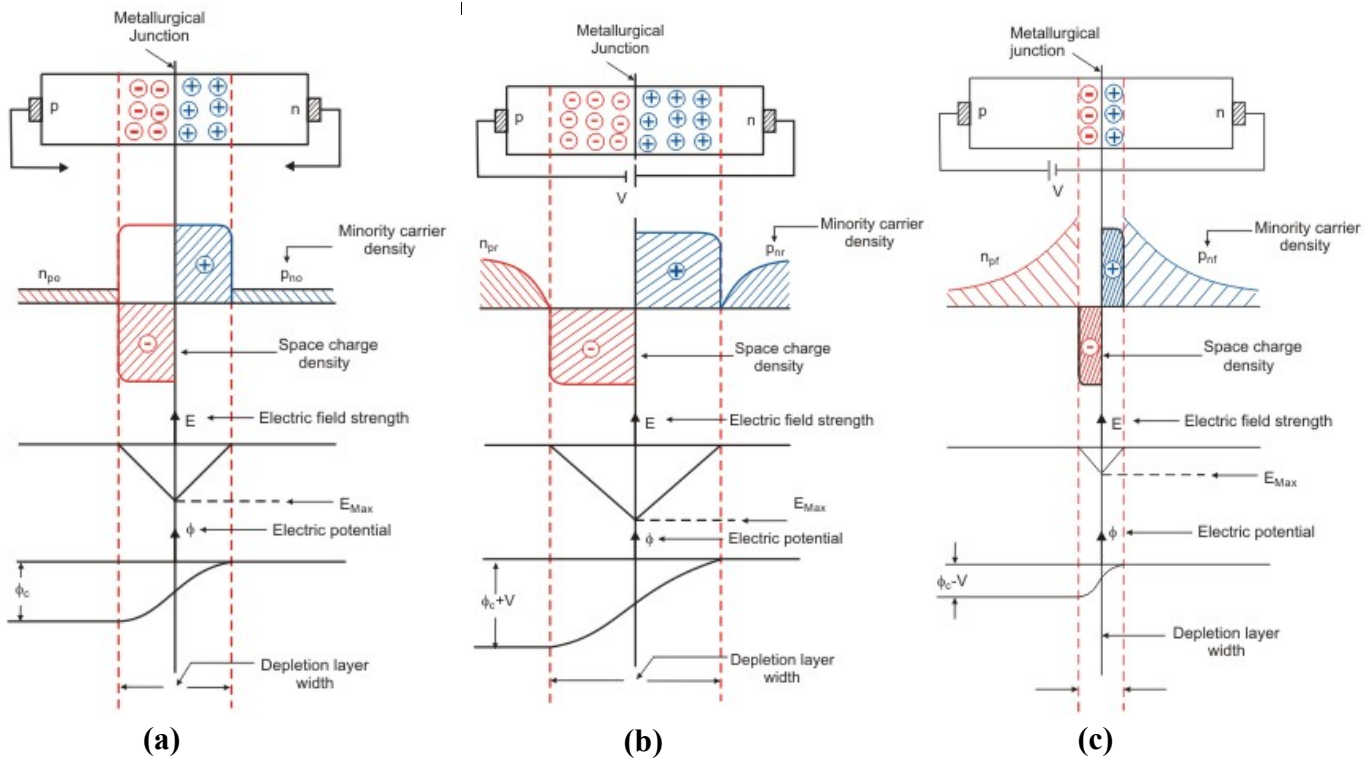

Fig 2.1: Space charge density the electric field and the electric potential in side a p-n junction under (a) thermal equilibrium condition, (b) reverse biased condition, (c) forward biased condition.

When an external voltage is applied with **p** side move negative then the **n** side the junction is said to be under reverse bias condition. This reverse bias adds to the height of the potential barrier. The electric field strength at the junction and the width of the space charge region (also called “the depletion region” because of the absence of free carriers) also increases. On the other hand, free minority carrier densities (n_p in the **p** side and p_n in the **n** side) will be zero at the edge of the depletion region on either side (Fig 2.1 (b)). This gradient in minority carrier density causes a small flux of minority carriers to diffuse towards the depletion layer where they are swept immediately by the large electric field into the electrical neutral region of the opposite side. This will constitute a small leakage current across the junction from the **n** side to the **p** side. There will also be a contribution to the leakage current by the electron hole pairs generated in the space charge layer by the thermal ionization process. These two components of current together is called the **“reverse saturation current I_s ”** of the diode. Value of I_s is independent of the reverse voltage magnitude (up to a certain level) but extremely sensitive to temperature variation.

When the applied reverse voltage exceeds some threshold value (for a given diode) the reverse current increases rapidly. The diode is said to have undergone **“reverse break down”**.

Reverse break down is caused by "impact ionization" as explained below. Electrons accelerated by the large depletion layer electric field due to the applied reverse voltage may attain sufficient kinetic energy to liberate another electron from the covalent bonds when it strikes a silicon atom. The liberated electron in turn may repeat the process. This cascading effect (avalanche) may produce a large number of free electrons very quickly resulting in a large reverse current. The power dissipated in the device increases manifold and may cause its destruction. Therefore, operation of a diode in the reverse breakdown region must be avoided.

When the diode is forward biased (i.e., **p** side more positive than **n** side) the potential barrier is lowered and a very large number of minority carriers are injected to both sides of the junction. The injected minority carriers eventually recombine with the majority carriers as they diffuse further into the electrically neutral drift region. The excess free carrier density in both **p** and **n** side follows exponential decay characteristics. The characteristic decay length is called the "minority carrier diffusion length"

Carrier density gradients on either side of the junction are supported by a forward current I_F (flowing from **p** side to **n** side) which can be expressed as

$$I_F = I_S(\exp(qv/kT)) - 1 \quad (2.1)$$

Where I_S = Reverse saturation current (Amps)

v = Applied forward voltage across the device (volts)

q = Charge of an electron

k = Boltzmann's constant

T = Temperature in Kelvin

From the foregoing discussion the $i-v$ characteristics of a **p-n** junction diode can be drawn as shown in Fig 2.2. While drawing this characteristics the ohmic drop in the bulk of the semiconductor body has been neglected.

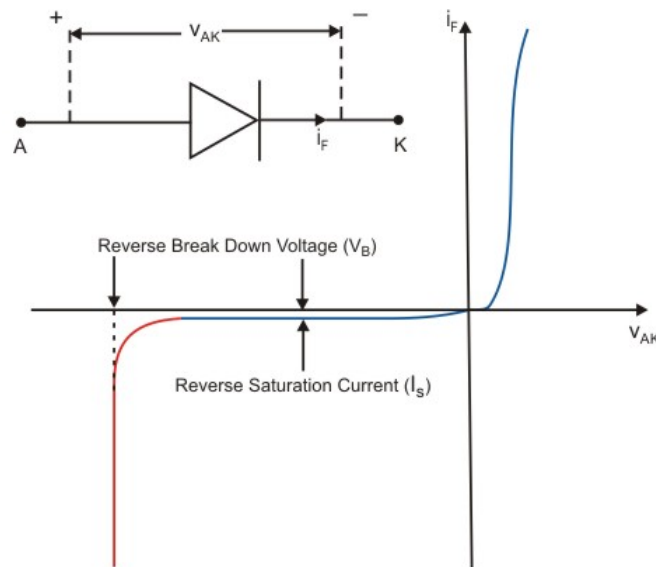

Fig 2.2: Volt-Ampere ($i-v$) characteristics of a **p-n junction diode**

Exercise 2.1

(1) Fill in the blanks with the appropriate word(s).

- (i) The width of the space charge region increases as the applied _____ voltage increases.
- (ii) The maximum electric field strength at the center of the depletion layer increases with _____ in the reverse voltage.
- (iii) Reverse saturation current in a power diode is extremely sensitive to _____ variation.

- (iv) Donor atoms are _____ carrier providers in the **p** type and _____ carrier providers in the **n** type semiconductor materials.
- (v) Forward current density in a diode is _____ proportional to the life time of carriers.

Answer: (i) Reverse, (ii) increase, (iii) temperature, (iv) Minority Majority, (v) inversely

(2) A **p-n** junction diode has a reverse saturation current rating of 50 nA at 32°C. What should be the value of the forward current for a forward voltage drop of 0.5V. Assume $V_T = KT/q$ at 32°C = 26 mv.

Answer

$$I_F = I_s \left(e^{V_F/V_T} - 1 \right), \quad I_s = 5 \times 10^{-8} \text{ A}, \quad V_T = 26 \times 10^{-3} \text{ V} \quad V = 0.5 \text{ V}$$

$$\therefore I_F = 11.24 \text{ Amps.}$$

(3) For the diode of Problem-2 calculate the dynamic ac resistance $r_{ac} = \frac{di_F}{dV_F}$ at 32°C and a forward voltage drop of 0.5V.

Answer:

$$i_F = I_s \left(e^{V_F/V_T} - 1 \right) \therefore \frac{di_F}{dV_F} = \frac{I_s}{V_T} e^{V_F/V_T}$$

$$\text{Now } I_s = 5 \times 10^{-8} \text{ A}, \quad V_F = 0.5 \text{ V},$$

$$V_T = 26 \times 10^{-3} \text{ V at } 32^\circ \text{ C}$$

$$\therefore \frac{dV_F}{di_F} = r_{ac} = \frac{V_T}{I_s} e^{-V_F/V_T} = 2.313 \text{ m}\Omega$$

2.3 Construction and Characteristics of Power Diodes

As mention in the introduction Power Diodes of largest power rating are required to conduct several kilo amps of current in the forward direction with very little power loss while blocking several kilo volts in the reverse direction. Large blocking voltage requires wide depletion layer in order to restrict the maximum electric field strength below the “impact ionization” level. Space charge density in the depletion layer should also be low in order to yield a wide depletion layer for a given maximum Electric fields strength. These two requirements will be satisfied in a lightly doped p-n junction diode of sufficient width to accommodate the required depletion layer. Such a construction, however, will result in a device with high resistivity in the forward direction. Consequently, the power loss at the required rated current will be unacceptably high. On the other hand if forward resistance (and hence power loss) is reduced by increasing the doping level, reverse break down voltage will reduce. This apparent contradiction in the requirements of a power diode is resolved by introducing a lightly doped “drift layer” of required

thickness between two heavily doped p and n layers as shown in Fig 2.3(c). Fig 2.3 (a) and (b) shows the circuit symbol and the photograph of a typical power diode respectively.

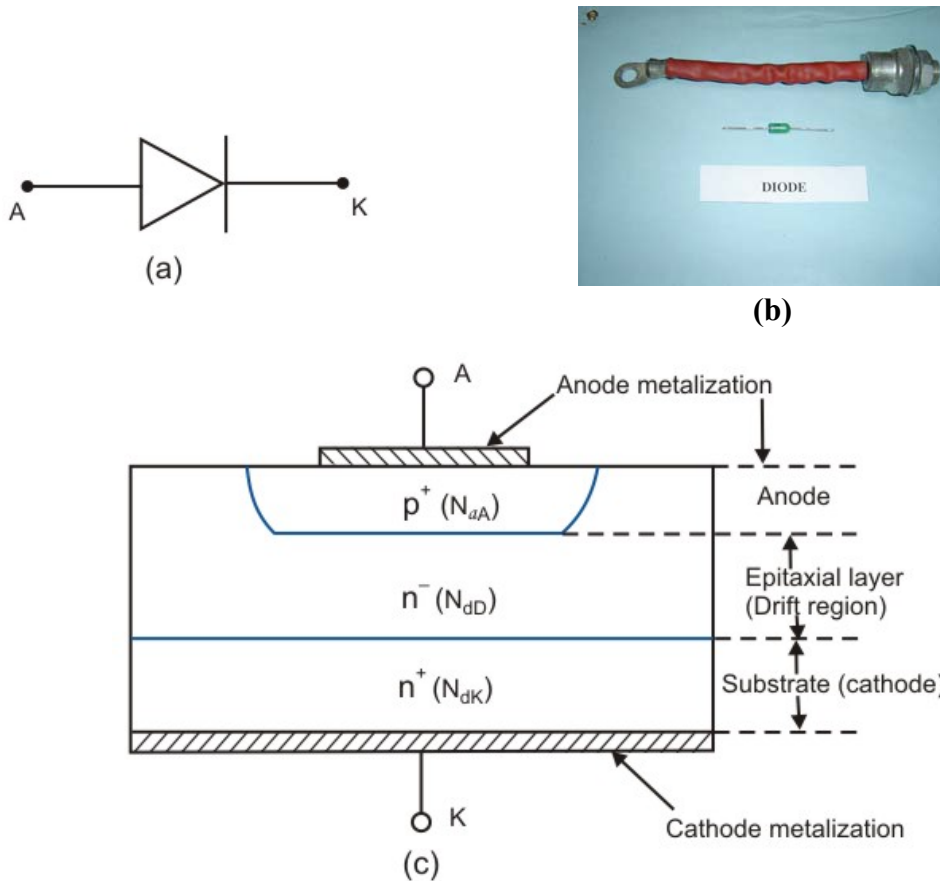

Fig. 2.3: Diagram of a power; (a) circuit symbol (b) photograph; (c) schematic cross section.

To arrive at the structure shown in Fig 2.3 (c) a lightly doped n^- epitaxial layer of specified width (depending on the required break down voltage) and donor atom density (N_{dD}) is grown on a heavily doped n^+ substrate (N_{dK} donor atoms. Cm^{-3}) which acts as the cathode. Finally the **p-n** junction is formed by defusing a heavily doped (N_{aA} acceptor atoms. Cm^{-3}) p^+ region into the epitaxial layer. This **p** type region acts as the anode.

Impurity atom densities in the heavily doped cathode ($N_{dk} \cdot \text{Cm}^{-3}$) and anode ($N_{aA} \cdot \text{Cm}^{-3}$) are approximately of the same order of magnitude (10^{19}Cm^{-3}) while that of the epitaxial layer (also called the drift region) is lower by several orders of magnitude ($N_{dD} \approx 10^{14} \text{Cm}^{-3}$). In a low power diode this drift region is absent. The Implication of introducing this drift region in a power diode is explained next.

2.3.1 Power Diode under Reverse Bias Conditions

[Back](#)

As in the case of a low power diode the applied reverse voltage is supported by the depletion layer formed at the $p^+ n^-$ metallurgical junction. Overall neutrality of the space charge region dictates that the number of ionized atoms in the p^+ region should be same as that in the n^- region. However, since $N_{dD} \ll N_{aA}$, the space charge region almost exclusively extends into the n^- drift

region. Now the physical width of the drift region (W_D) can be either larger or smaller than the depletion layer width at the break down voltage. Consequently two type of diodes exist, (i) non punch through type, (ii) punch through type. In “non-punch through” diodes the depletion layer boundary doesn’t reach the end of the drift layer. On the other hand in “punch through” diodes the depletion layer spans the entire drift region and is in contact with the n^+ cathode. However, due to very large doping density of the cathode, penetration of drift region inside cathode is negligible. Electric field strength inside the drift region of both these type of diodes at break down voltage is shown in Fig 2.4.

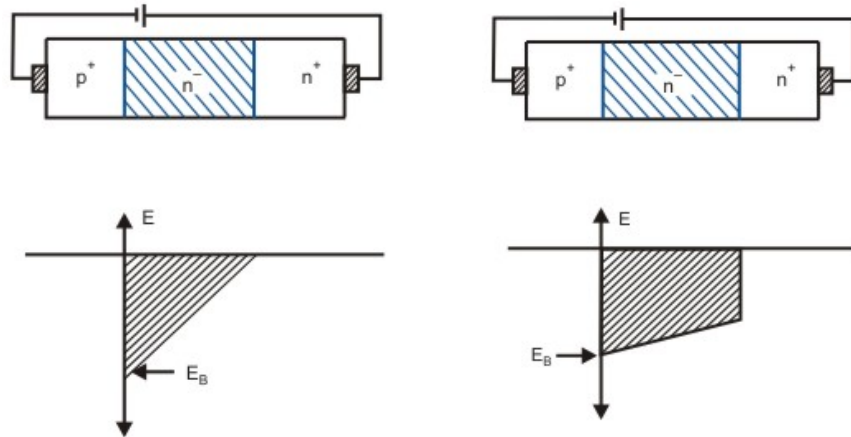

Fig 2.4: Electric field strength in reverse biased power Diodes; (a) Non-punch through type; (b) punch through type.

In non-punch through type diodes the electric field strength is maximum at the $p^+ n^-$ junction and decrease to zero at the end of the depletion region. Where as, in the punch through construction the field strength is more uniform. In fact, by choosing a very lightly doped n^- drift region, Electric field strength in this region can be made almost constant. Under the assumption of uniform electric field strength it can be shown that for the same break down voltage, the “punch through” construction will require approximately half the drift region width of a comparable “non - punch through” construction.

Lower drift region doping in a “punch through” diode does not carry the penalty of higher conduction losses due to “conductivity modulation” to be discussed shortly. In fact, reduced width of the drift region in these diodes lowers the on-state voltage drop for the same forward current density compared to a non-punch through diode.

Under reverse bias condition only a small leakage current (less than 100mA for a rated forward current in excess of 1000A) flows in the reverse direction (i.e from cathode to anode). This reverse current is independent of the applied reverse voltage but highly sensitive to junction temperature variation. When the applied reverse voltage reaches the break down voltage, reverse current increases very rapidly due to impact ionization and consequent avalanche multiplication process. Voltage across the device does not increase any further while the reverse current is limited by the external circuit. Excessive power loss and consequent increase in the junction temperature due to continued operation in the reverse break down region quickly destroys the diode. Therefore, continued operation in the reverse break down region should be avoided. A typical I-V characteristic of a power diode under reverse bias condition is shown in Fig 2.5.

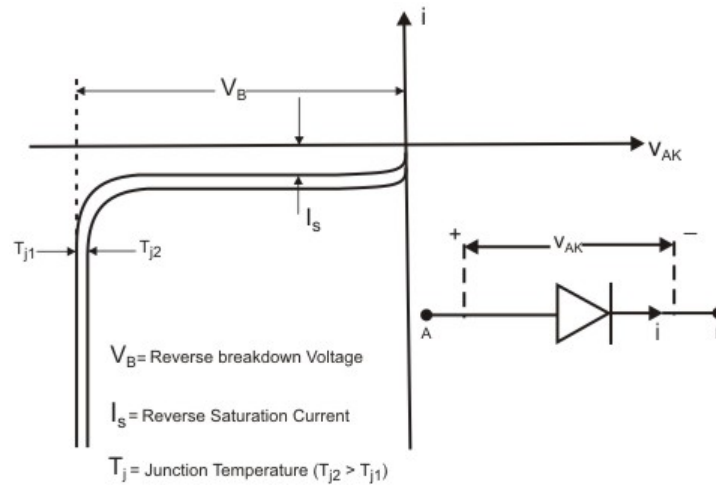

Fig 2.5: Reverse bias i-v characteristics of a power Diode.

A few other important specifications of a power Diode under reverse bias condition usually found in manufacturer's data sheet are explained below.

DC Blocking Voltage (V_{RDC}): Maximum direct voltage that can be applied in the reverse direction (i.e cathode positive with respect to anode) across the device for indefinite period of time. It is useful for selecting free-wheeling diodes in DC-DC Choppers and DC-AC voltage source inverter circuits.

RMS Reverse Voltage (V_{RMS}): It is the RMS value of the power frequency (50/60 HZ) sine wave voltage that can be directly applied across the device. Useful for selecting diodes for controlled / uncontrolled power frequency line commutated AC to DC rectifiers. It is given by the manufacturer under the assumption that the supply voltage may rise by 10% at the most. This rating is different for resistive and capacitive loads.

Peak Repetitive Reverse Voltage (V_{RRM}): This is the maximum permissible value of the instantaneous reverse voltage appearing periodically across the device. The time period between two consecutive appearances is assumed to be equal to half the power cycle (i.e 10ms for 50 HZ supply). This type of period reverse voltage may appear due to "commutation" in a converter.

Peak Non-Repetitive Reverse Voltage (V_{RSM}): It is the maximum allowable value of the instantaneous reverse voltage across the device that must not recur. Such transient reverse voltage can be generated by power line switching (i.e circuit Breaker opening / closing) or lightning surges.

Fig. 2.6 shows the relationship among these different reverse voltage specifications.

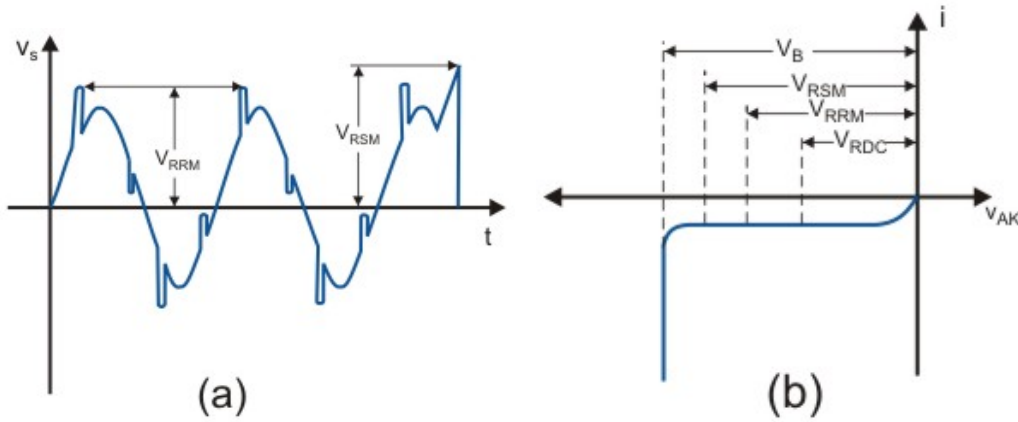

Fig. 2.6: Reverse Voltage ratings of a power diode; (a) Supply voltage wave form; (b) Reverse i-v characteristics

2.3.2 Power Diode under Forward Bias Condition

In the previous section it was shown how the introduction of a lightly doped drift region in the p-n structure of a diode boosts its blocking voltage capacity. It may appear that this lightly doped drift region will offer high resistance during forward conduction. However, the effective resistance of this region in the ON state is much less than the apparent ohmic resistance calculated on the basis of the geometric size and the thermal equilibrium carrier densities. This is due to substantial injection of excess carriers from both the p^+ and the n^+ regions in the drift region as explained next.

As the metallurgical p^+n^- junction becomes forward biased there will be injection of excess p type carrier into the n^- side. At low level of injections (i.e $\delta_p \ll n_{no}$) all excess p type carriers recombine with n type carriers in the n^- drift region. However at high level of injection (i.e large forward current density) the excess p type carrier density distribution reaches the n^-n^+ junction and attracts electron from the n^+ cathode. This leads to electron injection into the drift region across the n^-n^+ junction with carrier densities $\delta_n = \delta_p$. This mechanism is called “double injection”

Excess p and n type carriers diffuse and recombine inside the drift region. If the width of the drift region is less than the diffusion length of carries the spatial distribution of excess carrier density in the drift region will be fairly flat and several orders of magnitude higher than the thermal equilibrium carrier density of this region. Conductivity of the drift region will be greatly enhanced as a consequence (also called conductivity modulation).

The voltage dropt across a forward conducting power diode has two components i.e

$$V_{ak} = V_j + V_{RD} \quad (2.2)$$

Where V_j is the drop across the p^+n^- junction and can be calculated from equation (2.1) for a given forward current J_F . The component V_{RD} is due to ohmic drop mostly in the drift region. Detailed calculation shows

$$V_{RD} \propto J_F W_D \quad (2.3)$$

Where J_F is the forward current density in the diode and W_D is the width of the drift region. Therefore

$$V_{ak} = V_j + R_{ON} I_F \quad (2.3)$$

The ohmic drop makes the forward i-v characteristic of a power diode more linear.

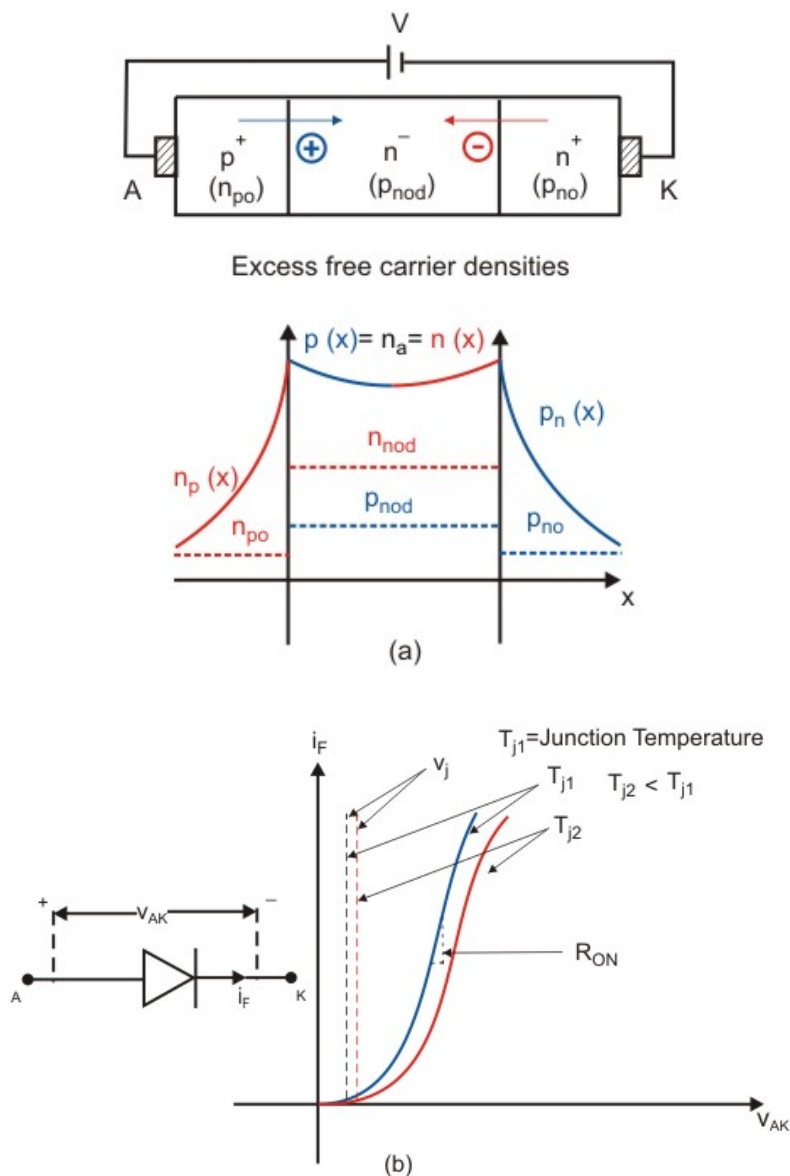

Fig 2.7: Characteristics of a forward biased power Diode; (a) Excess free carrier density distribution; (b) i-v characteristics.

Both V_j and V_{AK} have negative temperature coefficient as shown in the figure.

Few other important specifications related to forward bias operation of power diode as found in manufacturer's data sheet are explained next.

Maximum RMS Forward current (I_{FRMS}): Due to predominantly resistive nature of the forward voltage drop across a forward biased power diode, RMS value of the forward current determines the conduction power loss. The specification gives the maximum allowable RMS value of the forward current of a given wave shape (usually a half cycle sine wave of power frequency) and at a specified case temperature. However, this specification can be used as a guideline for almost all wave shapes of the forward current.

Maximum Average Forward Current (I_{FAVM}): Diodes are often used in rectifier circuits supplying a DC (average) current to be load. In such cases the average load current and the diode forward current usually have a simple relationship. Therefore, it will be of interest to know the

maximum average current a diode can conduct in the forward direction. This specification gives the maximum average value of power frequency half cycle sine wave current allowed to flow through the diode in the forward direction. Average current rating of a diode decreases with reduction in conduction angle due to increase in current “form factor”.

Both I_{FRMS} and I_{FAVM} ratings are given at a specified case temperature. If the case temperature increases beyond this limit these ratings has to be reduced correspondingly. “Derating curves” provide by the manufacturers give the relationship between I_{FAVM} (I_{FRMS}) with allowable case temperature as shown in Fig. 2.8.

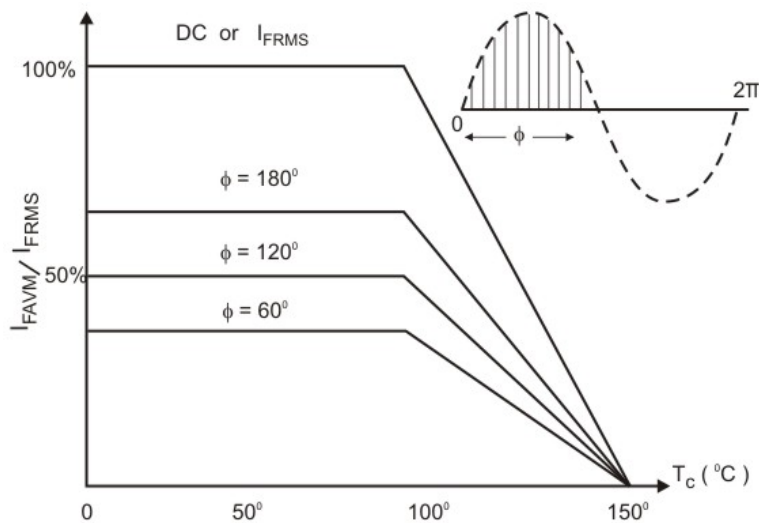

Fig 2.8: Derating curves for the forward current of a Power Diode.

Average Forward Power loss (P_{AVF}): Almost all power loss in a diode occurs during forward conduction state. The forward power loss is therefore an important parameter in designing the cooling arrangement. Average forward power loss over a full cycle is specified by the manufacturers as a function of the average forward current (I_{AVF}) for different conduction angles as shown in Fig 2.9.

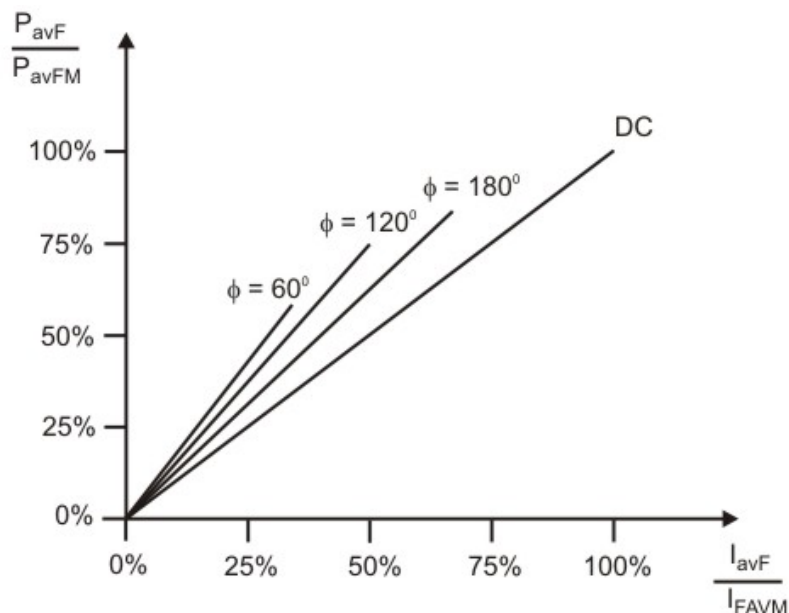

Fig 2.9: Average forward power loss vs. average forward current of a power Diode.

Surge and Fault Current: In some rectifier applications a diode may be required to conduct forward currents far in excess of its RMS or average forward current rating for some duration (several cycles of the power frequency). This is called the repetitive surge forward current of a diode. A diode is expected to operate normally after the surge duration is over.

On the other hand, fault current arising due to some abnormality in the power circuit may have a higher peak value but exists for shorter duration (usually less than an half cycle of the power frequency). A diode circuit is expected to be disconnected from the power line following a fault. Therefore, a fault current is a non repetitive surge current. Power diodes are capable of withstanding both types of surge currents and this capability is expressed in terms of two surge current ratings as discussed next.

Peak Repetitive surge current rating (I_{FRM}): This is the peak value of the repetitive surge current that can be allowed to flow through the diode for a specific duration and for specified conditions before and after the surge. The surge current waveform is assumed to be half sinusoidal of power frequency with current pulses separated by “OFF” periods of equal duration. The case temperature is usually specified at its maximum allowable value before the surge. The diode should be capable of withstanding maximum repetitive peak reverse voltage (V_{RRM}) and Maximum allowable average forward current (I_{FAVM}) following the surge. The surge current specification is usually given as a function of the surge duration in number of cycles of the power frequency as shown in figure 2.10

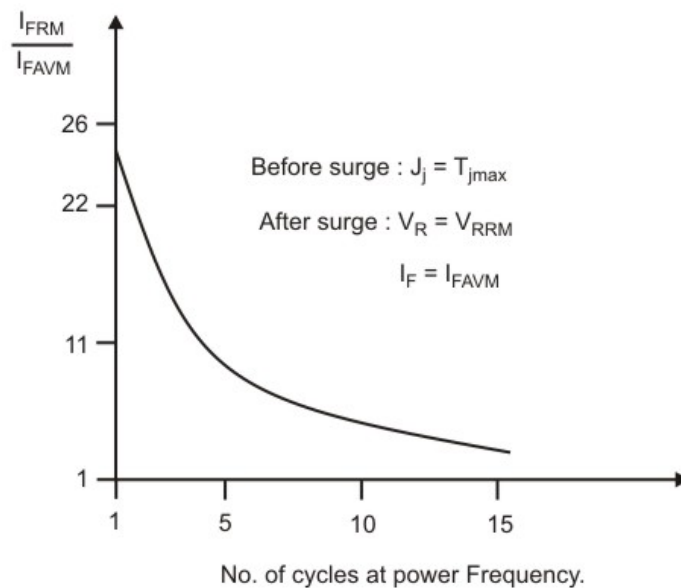

Fig 2.10: Peak Repetitive surge current VS time curve of a power diode.

In case the surge current is specified only for a fixed number of cycles ‘m’ then the surge current specification applicable to some other cycle number ‘n’ can be found from the approximate formula.

$$I_{FRM} \setminus_n = \sqrt{\frac{m}{n}} I_{FRM} \setminus_m \quad (2.4)$$

Peak Non-Repetitive surge current (I_{FRM}): This specification is similar to the previous one except that the current pulse duration is assumed to be within one half cycle of the power

frequency. This specification is given as a function of the current pulse duration as shown in Fig 2.11.

Maximum surge current Integral ($\int i^2 dt$): This is a surge current related specification and gives a measure of the heat energy generated inside the device during a non-repetitive surge. It is useful for selecting the protective fuse to be connected in series with the diode. This specification is also given as a function of the current pulse duration as shown Fig 2.11

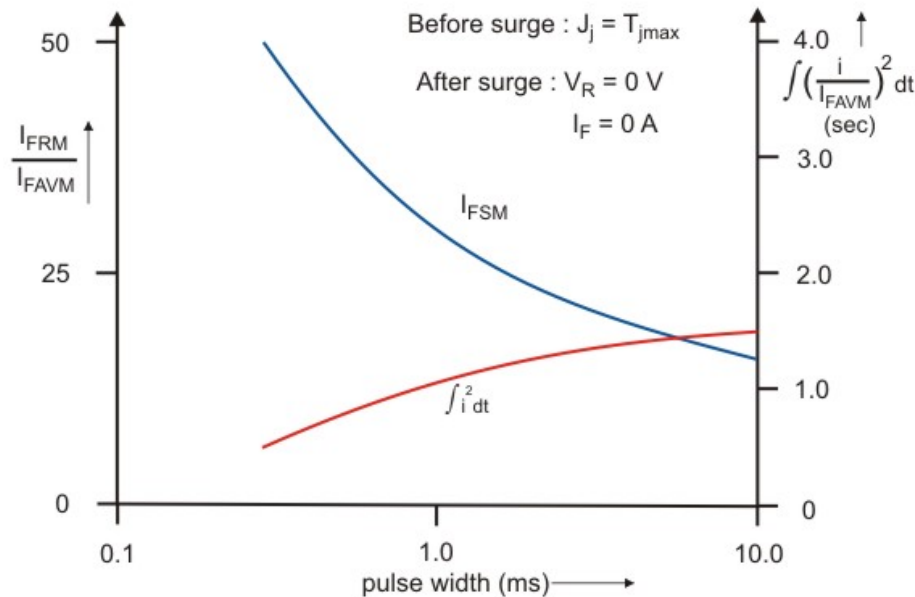

Fig. 2.11: Non-repetitive surge current and surge current integral vs. current pulse width characteristics of a power Diode.

Exercise 2.2

(1) Fill in the blanks with the appropriate word(s).

- i. The _____ region in a power diode increases its reverse voltage blocking capacity.
- ii. The maximum DC voltage rating (V_{RDC}) of a power diode is useful for selecting _____ diodes in a DC-DC chopper.
- iii. The reverse breakdown voltage of a Power Diode must be greater than _____.
- iv. The i-v characteristics of a power diode for large forward current is _____.
- v. The average current rating of a power diode _____ with reduction in the conduction angle due to increase in the current _____.
- vi. The derating curves of a Power diode provides relationship between the _____ and the _____.
- vii. $\int i^2 dt$ rating of a power diode is useful for selecting the _____.

Answer: (i) drift, (ii) free wheeling, (iii) V_{RSM} , (iv) linear, (v) decrease, form factor, (vi) I_{FAVM}/I_{FRM} , case temperature, (vii) protective fuse.

- (2). (a) For the single phase half wave rectifier shown find out the V_{RRM} rating of D.
 (b) Will the required V_{RRM} rating change if a inductor is placed between the diode and n capacitor.
 (c) What will be the required V_{RRM} rating if the capacitor is removed. Assume a resistive load.
 (d) The source of the single phase rectifier circuit has an internal resistance of $2\ \Omega$. Find out the required Non repetitive peak surge current rating of the diode. Also find the i^2t rating of the protective fuse to be connected in series with the diode.

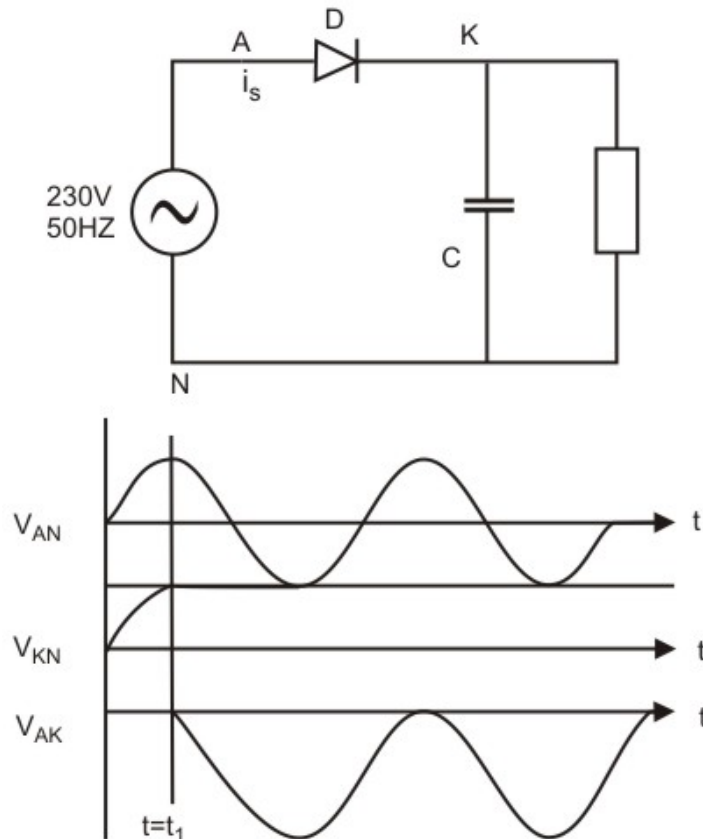

Answer: (a) During every positive half cycle of the supply the capacitor charges to the peak value of the supply voltage. If the load disconnected the capacitor voltage will not change when the supply goes through its negative peak as shown in the associated waveform. Therefore the diode will be subjected to a reverse voltage equal to the peak to peak supply voltage in each cycle. Hence, the required V_{RRM} rating will be

$$V_{RRM} = 2 \times \sqrt{2} \times 230V = 650V$$

(b) When an inductor is connected between the diode and the capacitor the inductor current will have some positive value at $t = t_1$. If the load is disconnected the stored energy in the inductor will charge the capacitor beyond the peak supply voltage. Since there is no discharge path for the capacitor this voltage across the capacitor will be maintained when the supply voltage goes through negative peak. Therefore, the diode will be subjected to a reverse voltage greater than the peak to peak supply voltage. The required V_{RRM} rating will increase.

(c) If the capacitor is removed and the load is resistive the voltage V_{KN} during negative half cycle of the supply will be zero since the load current will be zero. Therefore the reverse voltage across the diode will be equal to the peak supply voltage. So the required V_{RRM} rating will be

$$V_{RRM} = \sqrt{2} \times 230V = 325 \text{ Volts}$$

(d) Peak surge current will flow through the circuit when the load is accidentally short circuited. The peak surge current rating will be

$$I_{FSM} = \frac{\sqrt{2} \times 230}{2} \text{ A} = 162.64 \text{ A}$$

The peak non repetitive surge current should not recur. Therefore, the protective fuse (to be connected in series with the diode) must blow during the negative half cycle following the fault. Therefore the maximum i^2t rating of the fuse is

$$\int i^2 dt \Big|_{\text{Max}} = \int_0^\pi I_{FSM}^2 \sin^2 \omega t d\omega t = \frac{\pi}{2} I_{FSM}^2 = 41.55 \times 10^3 \text{ A}^2 \text{sec}$$

2.3.3 Switching Characteristics of Power Diodes

Power Diodes take finite time to make transition from reverse bias to forward bias condition (switch ON) and vice versa (switch OFF).

Behavior of the diode current and voltage during these switching periods are important due to the following reasons.

- Severe over voltage / over current may be caused by a diode switching at different points in the circuit using the diode.
- Voltage and current exist simultaneously during switching operation of a diode. Therefore, every switching of the diode is associated with some energy loss. At high switching frequency this may contribute significantly to the overall power loss in the diode.

Observed Turn ON behavior of a power Diode: Diodes are often used in circuits with di/dt limiting inductors. The rate of rise of the forward current through the diode during Turn ON has significant effect on the forward voltage drop characteristics. A typical turn on transient is shown in Fig. 2.12.

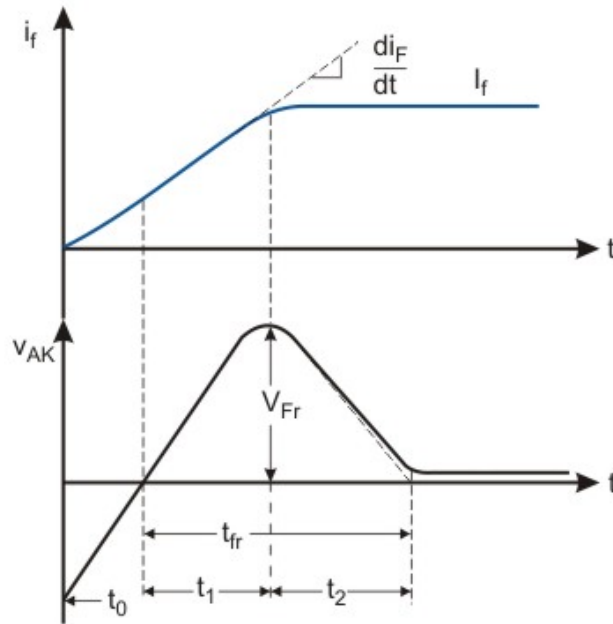

Fig. 2.12: Forward current and voltage waveforms of a power diode during Turn On operation.

It is observed that the forward diode voltage during turn ON may transiently reach a significantly higher value V_{fr} compared to the steady state voltage drop at the steady current I_F .

In some power converter circuits (e.g voltage source inverter) where a free wheeling diode is used across an asymmetrical blocking power switch (i.e GTO) this transient over voltage may be high enough to destroy the main power switch.

V_{fr} (called forward recovery voltage) is given as a function of the forward di/dt in the manufacturer's data sheet. Typical values lie within the range of 10-30V. Forward recovery time (t_{fr}) is typically within 10 μ s.

Observed Turn OFF behavior of a Power Diode: Figure 2.13 shows a typical turn off behavior of a power diode assuming controlled rate of decrease of the forward current.

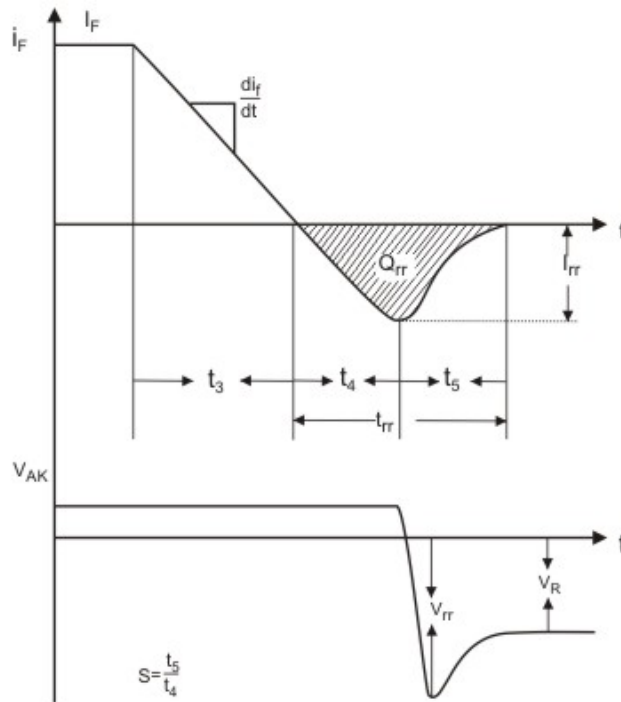

Fig. 2.13: Reverse Recovery characteristics of a power diode

Salient features of this characteristics are:

- The diode current does not stop at zero, instead it grows in the negative direction to I_{rr} called “peak reverse recovery current” which can be comparable to I_F . In many power electronic circuits (e.g. choppers, inverters) this reverse current flows through the main power switch in addition to the load current. Therefore, this reverse recovery current has to be accounted for while selecting the main switch.
- Voltage drop across the diode does not change appreciably from its steady state value till the diode current reaches reverse recovery level. In many power electric circuits (choppers, inverters) this may create an effective short circuit across the supply, current being limited only by the stray wiring inductance. Also in high frequency switching circuits (e.g, SMPS) if the time period t_4 is comparable to switching cycle qualitative modification to the circuit behavior is possible.
- Towards the end of the reverse recovery period if the reverse current falls too sharply, (low value of S), stray circuit inductance may cause dangerous over voltage (V_{rr}) across the device. It may be required to protect the diode using an RC snubber.

During the period t_5 large current and voltage exist simultaneously in the device. At high switching frequency this may result in considerable increase in the total power loss.

Important parameters defining the turn off characteristics are, peak reverse recovery current (I_{rr}), reverse recovery time (t_{rr}), reverse recovery charge (Q_{rr}) and the snappiness factor S .

Of these parameters, the snappiness factor S depends mainly on the construction of the diode (e.g. drift region width, doping level, carrier life time etc.). Other parameters are interrelated and also depend on S . Manufacturers usually specify these parameters as functions of di_F/dt for different values of I_F . Both I_{rr} and Q_{rr} increases with I_F and di_F/dt while t_{rr} increases with I_F and decreases with di_F/dt .

The reverse recovery characteristics shown in Fig. 2.13 is typical of a particular type of diodes called “normal recovery” or “soft recovery” diode ($S > 1$). The total recovery time (t_{rr}) in this case is a few tens of microseconds. While this is acceptable for line frequency rectifiers (these diodes are also called rectifier grade diodes) high frequency circuits (e.g PWM inverters, SMPS) demand faster diode recovery. Diode reverse recovery time can be reduce by increasing the rate of decrease of the forward current (i.e, by reducing stray circuit inductance) and by using “snappy” recovery ($S \ll 1$) diode. The problems with this approach are:

- i) Increase of di_F/dt also increases the magnitude of I_{rr}
- ii) Large recovery current coupled with ”snappy” recovery may give rise to current and voltage oscillation in the diode due to the resonant circuit formed by the stray circuit inductance and the diode depletion layer capacitance. A typical recovery characteristics of a “snappy” recovery diode is shown in Fig 2.14 (a).

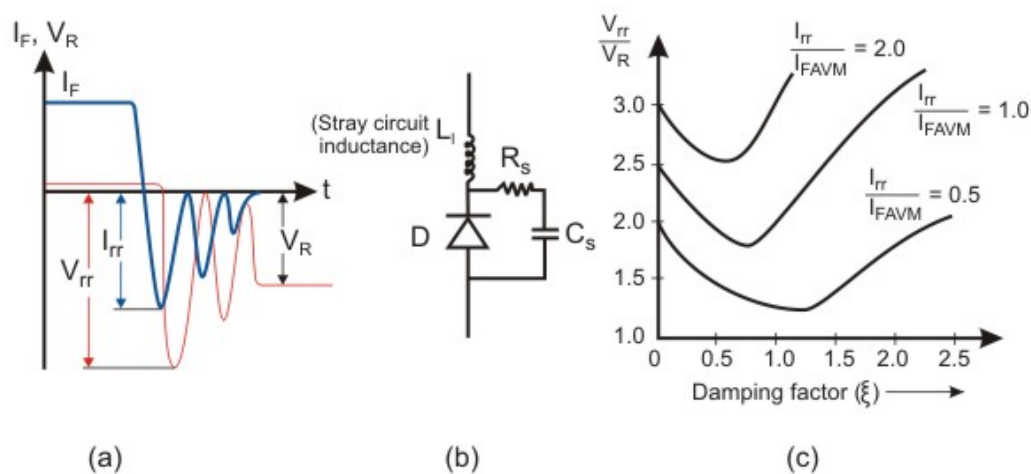

Fig. 2.14: Diode overvoltage protection circuit; (a) “Snappy recovery characteristics; (b) Capacitive snubber circuit; (c) snubber characteristics.

Large reverse recovery current may lead to reverse voltage peak (V_{rr}) in excess of V_{RSM} and destroy the device. A capacitive protection circuit (also called a “snubber circuit) as shown in Fig. 2.14 (b) may be used to restrict V_{rr} . Here the current flowing through L_1 at the time of diode current “snapping” is bypassed to C_s . L_1, R_s & C_s forms a damped resonance circuit and the initial energy stored in L_1 is partially dissipated in R_s , thereby, restricting V_{rr} . Normalized values of V_{rr} as a function of the damping factor ξ with normalized I_{rr} as a parameter is shown in Fig. 2.14(c).

However, it is difficult to correctly estimate the value of L_1 and hence design a proper snubber circuit. Also snubber circuits increase the overall power loss in the circuit since the energy stored in the snubber capacitor is dissipated in the snubber resistance during turning ON of the diode. Therefore, in high frequency circuits other types of fast recovery diodes (Inverter grade) are preferred. Fast recovery diodes offer significant reduction in both I_{rr} and t_{rr} (10% - 20% of a rectifier grade diode of comparable rating). This improvement in turn OFF performance, however, comes at the expense of the steady state performance. It can be shown that the forward voltage drop in a diode is directly proportion to the width of the drift region and inversely proportional to the carrier life time in the drift region. On the other hand both I_{rr} and t_{rr} increases with increase in carrier life time and drift region width. Therefore if I_{rr} and t_{rr} are reduced by reducing the carrier life time, forward voltage drop increases. On the other hand, if the drift

region width is reduced the reverse break down voltage of the diode reduces. The performance of a fast recovery diode is therefore, a compromise between the steady state performance and the switching performance. In high voltage high frequency circuits switching loss is the dominant component of the overall power loss. Therefore, some increase in the forward voltage drop in the diode (and hence conduction power loss) can be tolerated since the Turn OFF loss associated with reverse recovery is greatly reduced.

In some very high frequency applications ($f_{sw} > 100\text{KHZ}$), improvement in the reverse recovery performance offered by normal fast recovery diode is not sufficient. If the required reverse blocking voltage is less ($< 100\text{v}$) [schottky diodes](#) are preferred over fast recovery diodes. Compared to p-n junction diodes schottky diodes have very little Turn OFF transient and almost no Turn ON transient. On state voltage drop is also less compared to a **p-n** junction diode for equal forward current densities. However, reverse breakdown voltage of these diodes are less (below 200V) Power schottky diodes with forward current rating in excess of 100A are available.

Exerciser 2.3

1. Fill in the blanks with appropriate word(s)
 - i. Forward recovery voltage appears due to higher ohmic drop in the _____ region of a power diode in the beginning of the Turn On process.
 - ii. The magnitude of the forward recovery voltage is typically of the order of few _____ of volts.
 - iii. The magnitude of the forward recovery voltage also depends on the _____ of the diode forward current.
 - iv. The reverse recovery charge of a power diode increases with the _____ of the diode forward current.
 - v. For a given forward current the reverse recovery current of a Power Diode _____ with the rate of decrease of the forward current.
 - vi. For a given forward current the reverse recovery time of a Power diode _____ with the rate of decrease of the forward current.
 - vii. A “snappy” recovery diode is subjected to _____ voltage over shoot on recovery.
 - viii. A fast recovery diode has _____ reverse recovery current and time compared to a _____ recovery diode.
 - ix. A Schottky diode has _____ forward voltage drop and _____ reverse voltage blocking capacity.
 - x. Schottky diodes have no _____ transient and very little _____ transient.

Answer: (i) drift, (ii) tens, (iii) rate of rise, (iv) magnitude, (v) increases, (vi) decreases, (vii) large, (viii) lower, (ix) low, law, (x) Turn On, Turn Off.

2. In the buck converter shown the diode D has a lead inductance of $0.2\mu\text{H}$ and a reverse recovery charge of $10\mu\text{C}$ at $i_F = 10\text{A}$. Find peak current through Q.

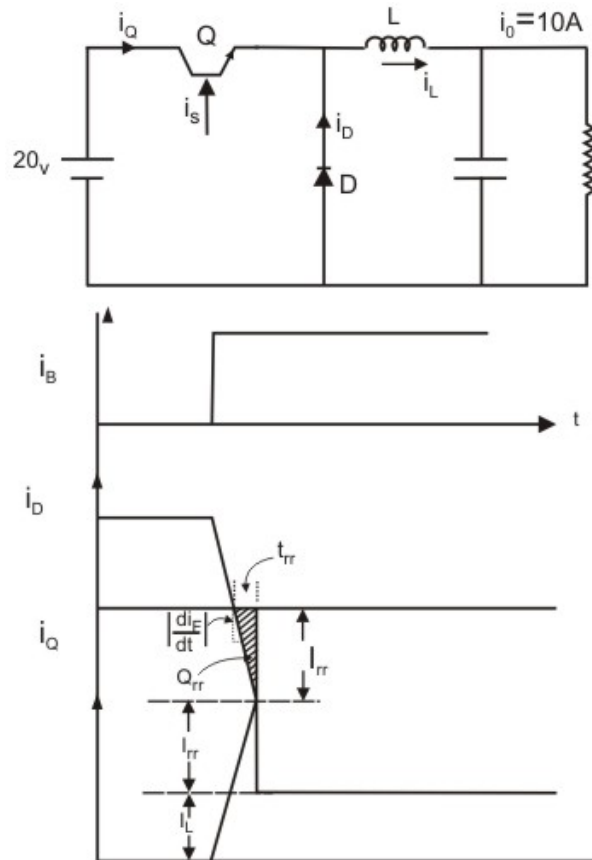

Answer: Assuming $i_L=10\text{A}$ (constant) the above waveforms can be drawn
As soon as Q is turned ON, a reverse voltage is applied across D and its lead inductance.

$$\therefore \left| \frac{di_F}{dt} \right| = \frac{20}{.2 \times 10^{-6}} \text{ A/Sec} = 10^7 \text{ A/Sec}$$

Assuming a snappy recovery diode ($s \approx 0$)

$$\begin{aligned} Q_{rr} &= \frac{1}{2} I_{rr} t_{rr} = \frac{1}{2} \left(\frac{di_F}{dt} \right) t_{rr}^2 \\ &= 10 \times 10^{-6} \text{ C} \end{aligned}$$

$$\therefore t_{rr} = 1.414 \mu\text{s}$$

$$\therefore I_{rr} = \left| \frac{di_F}{dt} \right| t_{rr} = 14.14 \text{ A}$$

$$\therefore i_Q \Big|_{\text{peak}} = I_L + I_{rr} = 24.14 \text{ A}$$

References

1. Ned Mohan, Tore M. Undeland, William P. Robbins, “Power Electronics, Converters, Application and Design” John Wiley & Sons(Asia), Publishers. Third Edition 2003.
2. P. C. Sen, “Power Electronics” Tata McGraw Hill Publishing Company Limited, New Delhi, 1987.
3. Jacob Millman, Christos C. Halkias, “Integrated Electronics, Analog and Digital Circuits and Systems”, Tata McGraw-Hill Publishing Company Limited, New Delhi, 1991.

Module Summary

- A p-n junction diode is a minority carrier, unidirectional, uncontrolled switching device.
- A power diode incorporates a lightly doped drift region between two heavily doped **p** type and **n** type regions.
- Maximum reverse voltage withstanding capability of a power diode depends on the width and the doping level of the drift region.
- A power diode should never be subjected to a reverse voltage greater than the reverse break down voltage.
- The i-v characteristics of a forward biased power diode is comparatively more linear due to the voltage drop in the drift region.
- The forward voltage drop across a conducting power diode depends on the width of the drift region but not affected significantly by its doping density.
- For continuous forward biased operation the RMS value of the diode forward current should always be less than its rated RMS current at a given case temperature.
- Surge forward current through a diode should be less than the applicable surge current rating.
- During “Turn On” the instantaneous forward voltage drop across a diode may reach a level considerably higher than its steady state voltage drop for the given forward current. This is called forward recovery voltage.
- During “Turn Off” the diode current goes negative first before reducing to zero. This is called reverse recovery of a diode.
- The peak negative current flowing through a diode during Turn Off is called the “reverse recovery current” of the diode.
- The total time for which the diode current remains negative during Turn Off is called “the reverse recovery time” of the diode.
- A diode can not block reverse voltage till the reverse current through the diode reaches its peak value.
- Both the “reverse recovery current” and the “reverse recovery time” of a diode depends on the forward current during Turn Off, rate of decrease of the forward current and the type of the diode.
- Normal or slow recovery diodes have smaller reverse recovery current but longer reverse recovery time. They are suitable for line frequency rectifier operation.
- Fast recovery diodes have faster switching times but comparatively lower break down voltages. They are suitable for high frequency rectifier or inverter free- wheeling operation.
- Fast recovery diodes need to be protected against voltage transients during Turn Off” using R-C snubber circuit.

- Schottky diodes have lower forward voltage drop and faster switching times but comparatively lower break down voltage. They are suitable for low voltage very high frequency switching power supply applications.

Practice Problems and Answers

Practice Problems (Module-2)

1. If a number of p-n junction diodes with identical i-v characteristics are connected in parallel will they share current equally? Justify your answer.
2. A power diode have a reverse saturation current of $15\mu\text{A}$ at 32°C which doubles for every 10° rise in temperature. The dc resistance of the diode is $2.5\text{ m}\Omega$. Find the forward voltage drop and power loss for a forward current of 200 Amps. Assume that the maximum junction temperature is restricted to 102°C .

$$V_T = k \frac{T}{q} = 26 \text{ mV at } 32^\circ\text{C}$$

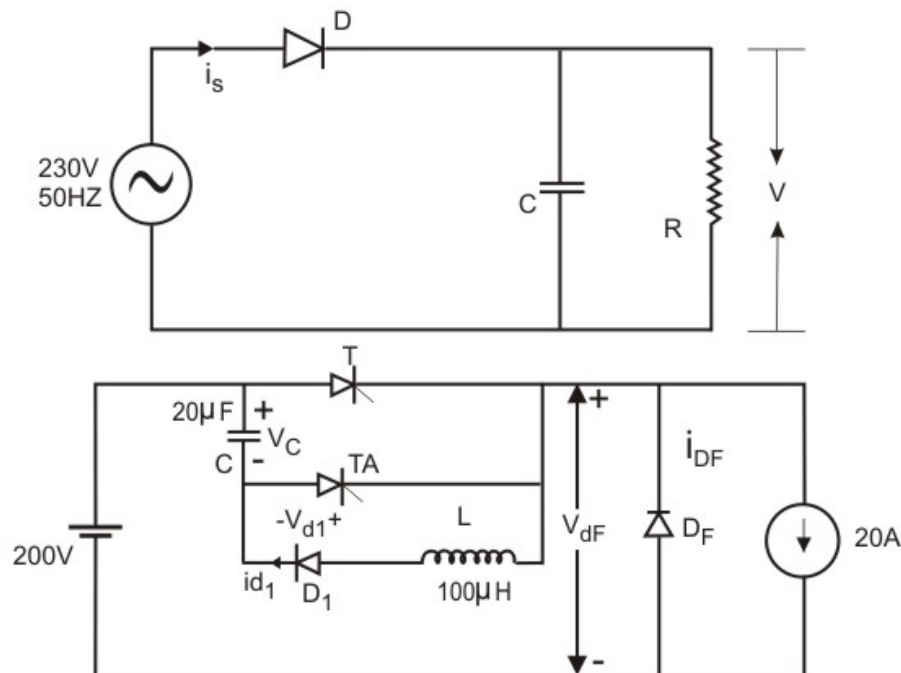

3. In the voltage commutated chopper T & TA are turned ON alternately at 400 HZ. C is initially charged to 200 V with polarity as shown. Find the I_{FRMS} and V_{RRM} ratings of D_1 & D_F .
4. In the voltage commutated chopper of Problem 5 the voltage on C reduces by 1% due to reverse recovery of D_1 . Find out I_{rr} & t_{rr} for D_1 . (Assume $S = 1$ for D_1).
5. What precaution must be taken regarding the forward recovery voltage of the free wheeling diodes in a PWM voltage source inverter employing Bipolar Junction Transistors of the **n-p-n** type?

Answers to Practice Problems

1. The reverse saturation current of a **p-n** junction diode increases rapidly with temperature. If follows then (from Eqn. 2.1) the voltage drop across a diode for a given forward current decreases with increase in temperature. In other words if the volt ampere characteristics of a diode is modeled as a non linear (current dependent) resistant it will have a negative temperature coefficient.

Let us now consider the situation where a number of diodes are connected in parallel. If due to some transient disturbance the current in a diode increases momentarily the junction temperature of that diode will increase due increased power dissipation. The voltage drop across that particular diode will decrease as a result and more current will be diverted towards that diode. This “positive feedback mechanism” will continue to increase its current share till parasitic lead resistance drop becomes large enough to prevent farther voltage drop across that diode. Therefore, it can be concluded that a number of **p-n** junction diodes conned in parallel will not, in general, share current equally even if it is assumed that they have identical i-v characteristics.

However, equal current sharing can be forced by connecting suitable resistances in series with the diodes so that the total resistance of each branch has positive temperature coefficient.

2. Since the reverse saturation current double with every 10°C rise in junction temperature.

$$I_s \Big|_{102^\circ\text{C}} = 2^{\frac{102-32}{10}} \times I_s \Big|_{32^\circ\text{C}} = 1.92 \text{ mA}$$

$$V_t = \frac{KT}{q} = 26\text{mv at } 32^\circ\text{C} \quad \therefore V_t \text{ at } 102^\circ = 31.97\text{mv}$$

$$\therefore V_j \text{ for } i_F = 200 \text{ A is}$$

$$V_j = V_t \Big|_{102^\circ\text{C}} \times \ln \frac{i_F}{I_s \Big|_{102^\circ\text{C}}} = 0.37 \text{ V}$$

$$\text{Voltage drop across drift region } V_R = i_F \times R_D = 0.5 \text{ V}$$

Therefore, the total voltage drop across the diode is

$$V_D = V_R + V_j = 0.87 \text{ V}$$

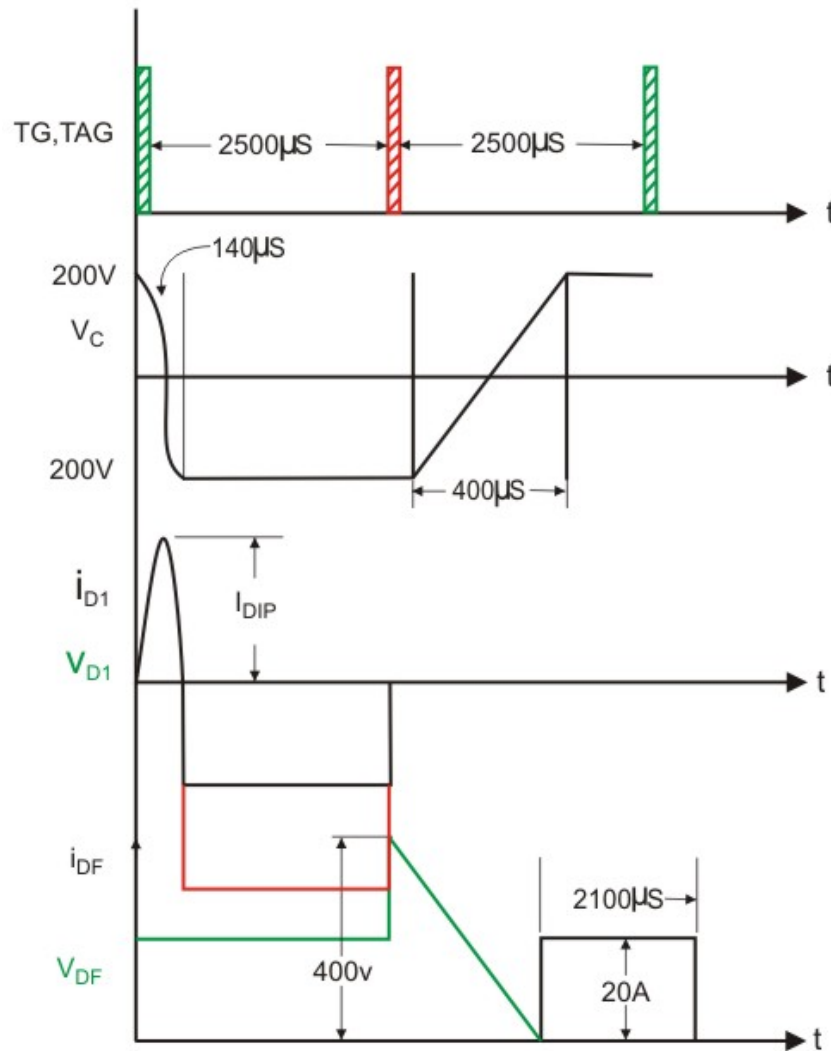

3. Important wave forms of the system are shown in the figure.
 As soon as T is turned ON the capacitor voltage starts reversing due to the L-C resonant circuit formed by C-T-L & D₁. Neglecting all the capacitor voltage reaches a -200V.

The current i_{di} is given by

$$i_{DI} = I_{DIP} \sin \omega_n \quad 0 \leq \omega_n \leq \pi$$

where $I_{DIP} = 200 \sqrt{\frac{C}{L}} = 89.44 \text{ A}$

$$\& \omega_n = \frac{1}{\sqrt{LC}} = 22.36 \times 10^3$$

∴ Capacitor voltage reversal time

$$= \frac{T_n}{2} = \frac{1}{2 f_n} = \frac{\pi}{\omega_n} = 140 \mu\text{s}.$$

Capacitor voltage remains at -200 V till TA is turned ON when it is charged linearly towards +200 V. Time taken for charging is

$$T_C = \frac{2 \times 200 \times C}{I_L} = 400 \mu\text{s}$$

At the end of charging DF turns ON and remains on till T is turned on again.

$$\therefore I_{\text{FRMS}} \text{ For } D_I \text{ is } \frac{I_{\text{DIP}}}{\sqrt{2}} \sqrt{\frac{140}{5000}} = 10.58 \text{ Amps}$$

$$I_{\text{FRMS}} \text{ For } D_F \text{ is } 20 \sqrt{\frac{2100}{5000}} = 12.96 \text{ Amps}$$

From figure V_{RRM} for D_I is 200 V

V_{RRM} for D_F is 400 V

4. Since the Capacitor voltage reduces by 1%

$$Q_{\text{rr}} = 0.01 \times C \times 200 = 40 \mu\text{c}$$

$$\text{with } S = 1 \quad Q_{\text{rr}} = I_{\text{rr}} t_{\text{rr}} = \left| \frac{di_{\text{dI}}}{dt} \right| t_{\text{rr}}^2$$

$$\text{Now } id_I = I_{\text{DIP}} \text{ Sin } \omega_n t$$

$$\therefore \frac{di_{\text{dI}}}{dt} = \omega_n I_{\text{DIP}} \text{ Cos } \omega_n t$$

$$\text{at } \omega_n t = \pi, \left| \frac{di_{\text{dI}}}{dt} \right| = \omega_n I_{\text{DIP}} = \frac{1}{\sqrt{LC}}, 200 \sqrt{\frac{C}{L}} = 2 \text{ A}/\mu\text{s}$$

$$\therefore t_{\text{rr}}^2 = 20 \times 10^{-12} \text{ sec}^2 \quad \text{or } t_{\text{rr}} = 4.472 \mu\text{s}$$

$$\therefore I_{\text{rr}} = 8.94 \text{ Amps}$$

5. Figure shows one leg of a PWM VSI using **n-p-n** transistor and freewheeling diode.

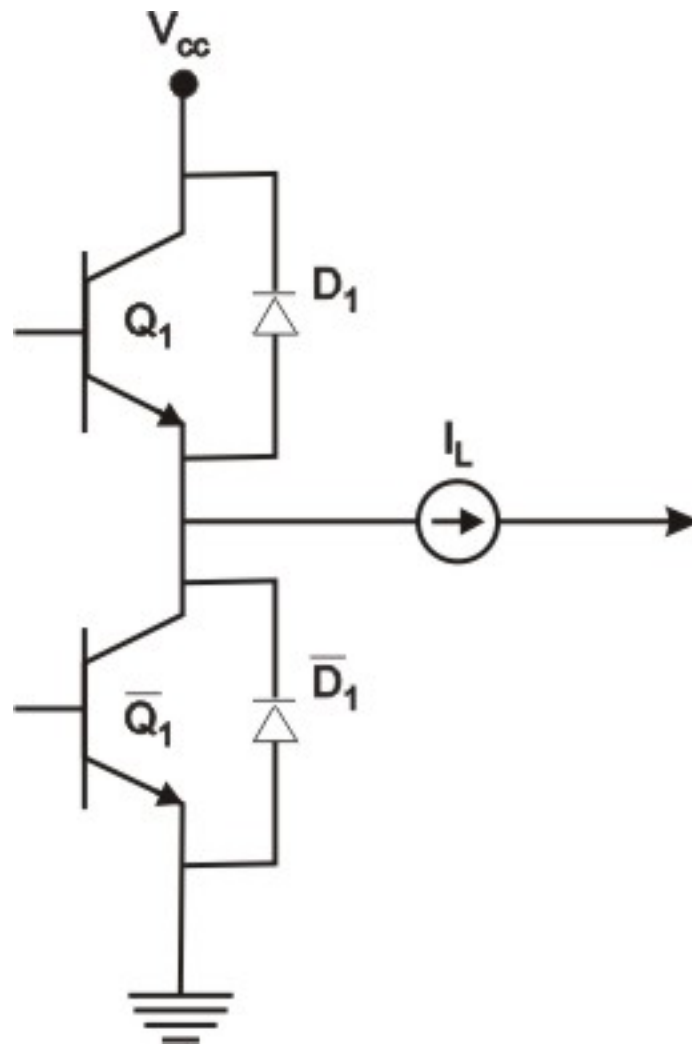

Consider turning off operation of Q_1 . As the current through Q_1 reduces \bar{D}_1 turns On. The forward recovery voltage of \bar{D}_1 appears as a reverse voltage across the **n-p-n** transistor whose base emitter junction must with stand this reverse voltage. Therefore, the forward recovery voltage of the free wheel diodes must be less then the reverse break down voltage of the base-emitter junction of the **n-p-n** transistors for safe operation of the inverter.